

Model No.

# ESP-82TW

Pendant Speaker

## INCLUDES:

- 8-inch 120W coaxial driver
- 120W transformer (with bypass)
- Plastic enclosure with magnetic-mount top
- Press-fit grille, scrim, pull tool



*The magnetic-mount top hides an integral bracket for cable or pipe installation. An optional U-bracket can be added to threaded insert points on the sides for wall or truss-mount.*

VERSATILE-MOUNT ESP PENDANT SPEAKERS are engineered to acoustically match ES SERIES recessed speakers, enabling the integration of exceptional performance with even coverage no matter the type of architecture encountered. The ESP produces excellent intelligibility for speech and full frequency response for music, making it ideal for retail, commercial, industrial, institutional and even some residential applications.

## FEATURES

**PERFORMANCE:** The ESP is suitable for a wide variety of applications that require clear speech and full frequency music.

**DRIVER:** 8-inch 120W coaxial

- High frequency, horn-loaded silk dome tweeter for crisp response
- Wide dispersion (105 degree conical) can reduce the number of speakers required for even coverage in distributed speaker systems.

**TRANSFORMER:** 120W

- Tap selections for 25V, 70V or 100V speaker systems
- 4ohm (UL minimum) transformer bypass position.
- Selector switch is on bottom baffle, behind grille.

**GRILLE:** Fine mesh 20-gauge CRS press-fit grille with UV-rated white powder coating.

- Includes scrim and pull tool.

**ENCLOSURE:** Durable white ABS plastic with matching magnetic-mount top cover to hide wire connections and rigging hardware.

- Tapered shape
- Ported enclosure tuned for extended bass response

**COMPLIANCE:**

- UL1480A General Signaling, USA
- CSA C22.2 No.205-12 General Signaling, Canada

## INSTALLATION

- Install with cable or pipe using the integral mounting bracket (hidden by magnetic-mount top cover), or convert to wall/truss mount by adding the optional U-bracket to threaded insert points on the sides.
- Removable (4 pin) Phoenix-style connector with two terminals for input to speaker and two parallel terminals for output to next speaker in string.
- Order mounting hardware separately.

## ACCESSORIES (order separately)

- **ESP-CBL Gripple Cable & Fastener Kit:** Includes two Gripple No. 2 hook-end hanging cables with quick-install Express fasteners, each with a load rating of 100 lbs. (5:1 safety factor). In a typical cable installation, one cable handles primary suspension, while the second serves as the required safety cable.
- **ESP-8-BRKTW Bracket:** White U-style bracket attaches to the speaker at threaded insert points for wall or truss-mount.
- **ESP-8-PG Paint Guards:** Plastic guards for 8-inch speakers. 10-pack.



## FEATURES



8-inch 120W coaxial driver with high-frequency horn-loaded silk dome tweeter.

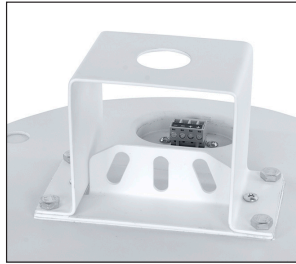

Integral top bracket is ready for cable or pipe installation.



Front tap selector switch is protected behind the press-fit grille.



Fine mesh press-fit grille includes scrim and pull tool.

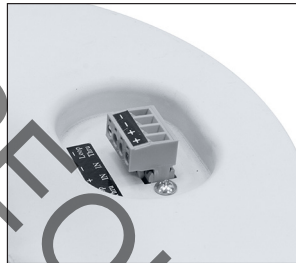

Removable Phoenix style connector has two terminals for input and two for output.

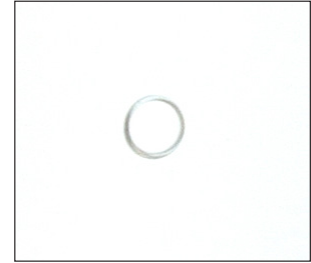

Side plugs normally cover threaded insert points (remove to mount optional U-bracket).

## VERSATILE INSTALLATION

The ESP speaker does not include mounting hardware — order separately.



Cables (primary and safety)



Pipe with safety cable



U-bracket

**WARNING!** Pendant-mount speaker installation should only be performed by experienced qualified professionals with a complete working knowledge of load-rated hardware and safe installation, mounting, and rigging techniques. Improperly installed equipment can result in property damage, personal injury, death, and/or liability for the installing contractor. The speaker system must be mounted in accordance with all local, state, and federal building codes and regulations and the installation must conform to industry standard practices. It is the responsibility of the installer to properly select all installation hardware, rigging hardware, and safety or restraint cables to be used. BEFORE INSTALLATION, it is the responsibility of the installer to consult a licensed mechanical or structural engineer to evaluate and certify the structural integrity and safety of any mounting method and the suitability of that method to be used to mount the pendant loudspeaker to the building structure in this particular installation. All speaker rigging systems must be designed with a minimum of a 5X safety factor. Lowell Manufacturing Company is not responsible for the use, misuse, misapplication, or unsafe installation of any loudspeaker that it has manufactured.

## TECHNICAL DRAWINGS

Dimensions are inches and [mm] unless stated otherwise.

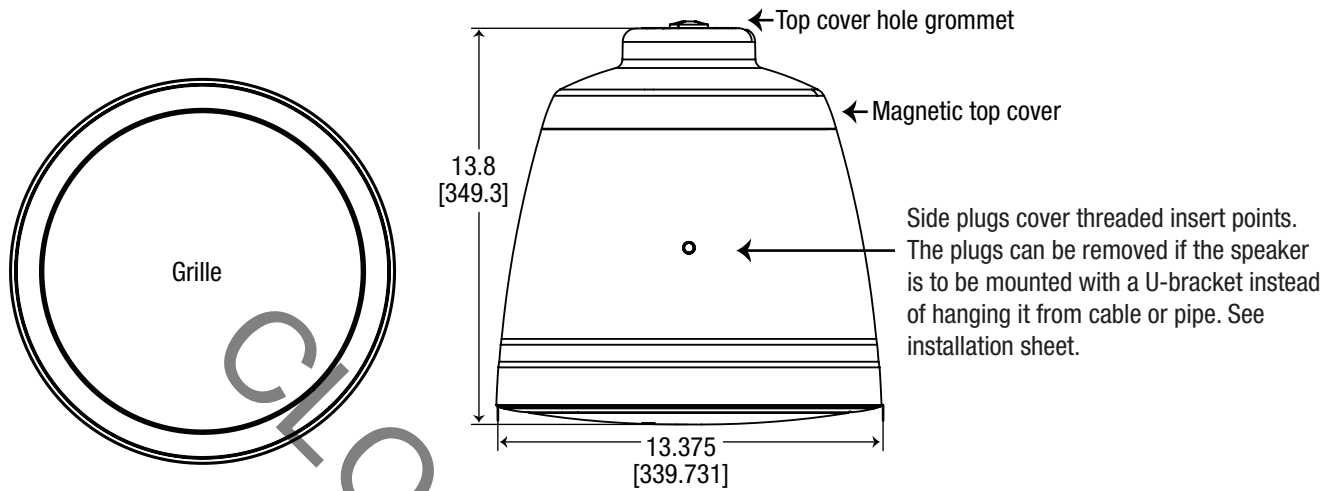

## SPL VS. FREQUENCY (1W/1M)

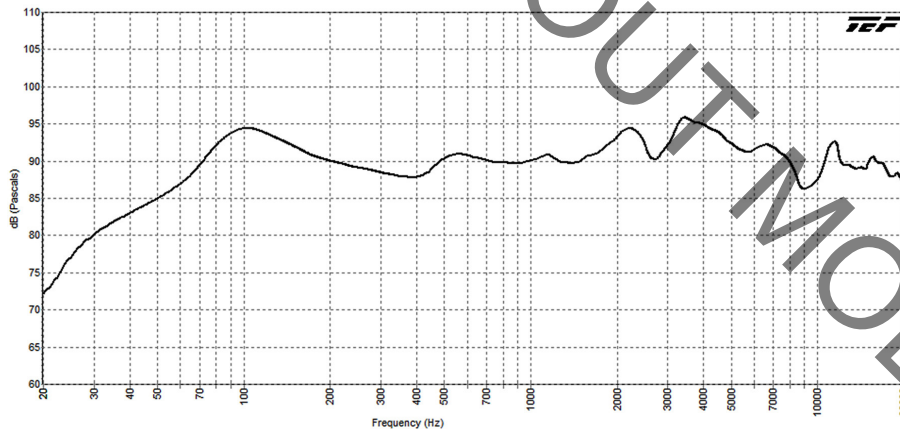

## IMPEDANCE

Impedance reading expected from a typical 1kHz impedance meter is 9.5 ohms with the selector switch in the 4 ohm position.

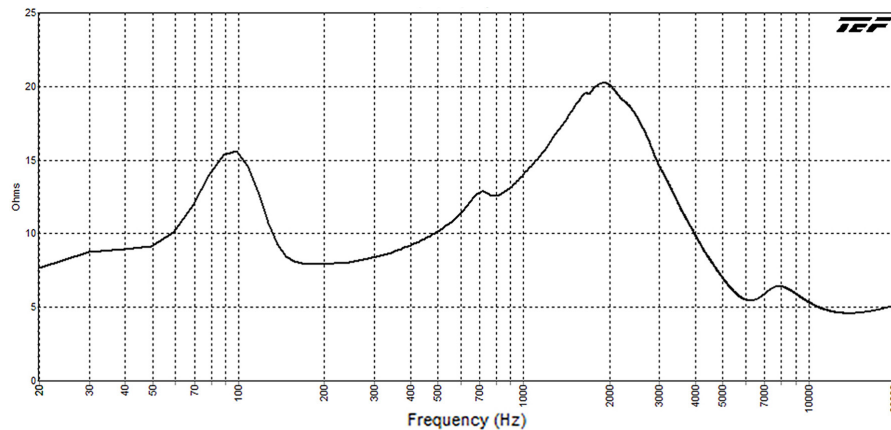

## POLAR DATA

360 degrees (full space mounting)

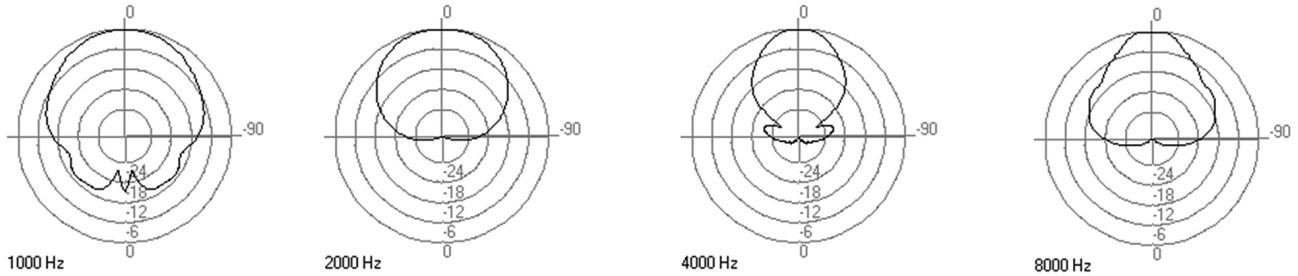

## TECHNICAL DATA

### PERFORMANCE:

Power Handling: . . . . . 120W RMS (at 8 ohms) measured per EIA Standard RS-426B  
 Sensitivity: . . . . . 90.0 dB log average SPL (at 8 ohms) @1W/1M over the frequency response range, measured in full-space.  
 Maximum SPL: . . . . . 110.8 dB (calculated based on power rating and measured 8 ohm sensitivity).  
 Impedance: . . . . . 8 ohms (nominal), 4.6 ohms @ 14 kHz (min.)  
 Frequency Response: . . . . . 64Hz – 20kHz (±6dB)  
 Conical Dispersion Angle: . . . 105 degrees conical @2kHz octave (-6dB)  
 Crossover Frequency: . . . . . 1.8kHz  
 Transformer Taps: . . . . . 100V (120, 60, 30, 15W); 70V (120, 60, 30, 15, 7.5W); 25V (15, 7.5, 3.75, 1.88, 0.94W)

### PHYSICAL (Full Range Speaker):

Woofer Cone: . . . . . Coated paper cone  
 Surround: . . . . . Rubber  
 Woofer Magnet Weight: . . . . . 19.2 oz. (544.7g)  
 Woofer Voice Coil Dia.: . . . . . 1.2 inch (30.55mm)  
 Tweeter Cone: . . . . . Silk dome  
 Tweeter Magnet Weight: . . . . . 0.45 oz. (12.8g)  
 Tweeter Voice Coil Dia.: . . . . . 1-inch (25.4mm)

### MECHANICAL:

Input Terminals: . . . . . 4-conductor removable Phoenix-style connector  
 Net Weight (speaker & grille) . . 15.6 lbs. [7.08kg]  
 Shipping Weight: . . . . . 19.4 lbs. [8.80kg]  
 Height: . . . . . 13.8 in. [349.3mm]  
 Diameter: . . . . . 13.375 in. [339.731mm]

### MOUNTING:

Cable Suspension: . . . . . Requires accessory ESP-CBL and additional mounting hardware (supplied by installer) to attach to the building structure.  
 Pipe Suspension: . . . . . Requires half of accessory ESP-CBL (one cable for use as a safety cable) plus pipe and fittings to attach to the building structure (supplied by installer.)  
 U-Bracket Mount: . . . . . Requires accessory ESP-8-BRKTW plus mounting hardware (supplied by installer)

TEST METHODOLOGIES: Lowell speaker systems are thoroughly tested to provide specifiers and contractors with accurate data. Test equipment includes the GoldLine TEF-20 analyzer.

- **POWER HANDLING:** specification is based on E.I.A. Standard RS-426B.
- **FREQUENCY RESPONSE:** describes the usable response range defined by a ± 6dB window, which is useful in predictive engineering calculations.
- **SENSITIVITY:** is a computer calculation of the log average sound pressure level (SPL) over the entire engineering bandwidth as given in the Frequency Response (±6dB).
- **MAXIMUM SPL:** is calculated based on the Power Handling and the measured log average Sensitivity where Maximum SPL = (Sensitivity @ 1W1M) + 10 log (Power Handling).
- **DISPERSION ANGLE:** is defined as the angle of coverage that is no more than 6dB down from the on-axis value averaged over the 2kHz octave band. Since speech intelligibility is dependent upon the 2kHz octave, this specification is useful in designing voice reinforcement and music systems that provide even coverage and intelligibility. The polar plots illustrate how the system performs when hung in free space (360°) or half-space (180°) in the case of a recessed speaker.

## A&E SPECIFICATIONS

The loudspeaker shall be Lowell ESP-82TW, which shall include a high-performance 8-inch coaxial driver, ported bass reflex enclosure and press-fit grille for pendant mount (or U-bracket mount with optional bracket). Frequency response shall be 64Hz-20kHz ( $\pm 6$ dB). Sensitivity shall be 90.0dB log average @1W/1M over the frequency response range, measured in full-space. The speaker shall be constructed of a coated paper cone with rubber surround and a silk dome tweeter. The woofer magnet weight shall be a minimum of 19.2 oz. (544.7g) and the woofer voice coil diameter shall be 1.2-in. (30.55mm). The transformer shall have primary taps for 100V (120, 60, 30, 15 watt); 70V (120, 60, 30, 15, 7.5 watt); and 25V (15, 7.5, 3.75, 1.88, 0.94 watt) with a selector switch mounted on the front under the grille that will include a 4ohm (UL minimum) transformer bypass position. The enclosure shall be white ABS plastic featuring a main body, magnetic cover, and bottom baffle where the driver shall be mounted. The enclosure shall feature a bracket assembly to accommodate cable or pipe hanging installations (cable/pipe not included). A four-conductor Phoenix style removable connector shall be located under the magnetic cover to allow input wiring and parallel output wiring to the next speaker. The unit shall include a fine mesh 20-gauge CRS press-fit grille with UV rated powder coating (white), scrim and pull tool.

## ESP SERIES OVERVIEW

Model No.	Driver	Transformer*	Overall Height	Overall Diameter	Net Weight	Color	System Specs (measured full space)	
							Sensitivity**	Frequency Response
ESP-62TB	6-1/2" 50W coaxial	32W	12.6"	10.0"	8.3 lbs.	black	88.6 dB	64Hz-20kHz ( $\pm 6$ dB)
ESP-62TW	6-1/2" 50W coaxial	32W	12.6"	10.0"	8.3 lbs.	white	88.6 dB	64Hz-20kHz ( $\pm 6$ dB)
ESP-82TB	8" 120W coaxial	120W	13.8"	13.375"	15.6 lbs.	black	90.0 dB	64Hz-20kHz ( $\pm 6$ dB)
ESP-82TW	8" 120W coaxial	120W	13.8"	13.375"	15.6 lbs.	white	90.0 dB	64Hz-20kHz ( $\pm 6$ dB)
ESP-82CDTB	8" 150W coaxial compression	120W	13.8"	13.375"	19.1 lbs.	black	91.5 dB	67Hz-20kHz ( $\pm 6$ dB)
ESP-82CDTW	8" 150W coaxial compression	120W	13.8"	13.375"	19.1 lbs.	white	91.5 dB	67Hz-20kHz ( $\pm 6$ dB)

\* Includes transformer bypass position

\*\* Average Sensitivity: SPL @ 1W/1M

\*\*\* Conical Dispersion @ 2kHz octave ( $-6$ dB)

**Note on Speaker Spacing:** Conical dispersion measurements are provided for comparison with other speakers. To determine correct speaker spacing, see the technical paper "Distributed & Spacing for the Integrator" (free download at [www.Lowellmfg.com](http://www.Lowellmfg.com)) which explains the difference between conical and linear dispersion and the measurements to use for best results. For qui