



features

- **Description:** The universal vertical turn (radius bend) attaches to a straight ladder to continue proper cable bend while changing elevation or direction (horizontal to vertical or vice versa). It can be used as an inside or outside bend and is designed to conform with minimum cable bend radius requirements.
- **Ladder Width:** 18.00 in.
- **Construction:**
 - Sides: 1-1/2 x 3/8 x .06 wall tubular steel
 - Rungs: 1 x 1/2 x .06 wall tubular steel
 - Color: Black
- **Standards:**
 - Conforms to EIA-310 standard.
 - RoHS compliant components.
 - Made in the U.S.A.
- **Installation:** Easy to install using butt-slice kit (order separately).

a&e specifications

The 18 in. wide cable ladder shall include a universal vertical radius bend to change direction (horizontal to vertical or vice versa), Lowell Model #CL-18VT. The unit shall be suitable for use as an inside or outside bend. It shall be made in the U.S.A. to conform to EIA-310 standard.

technical drawings

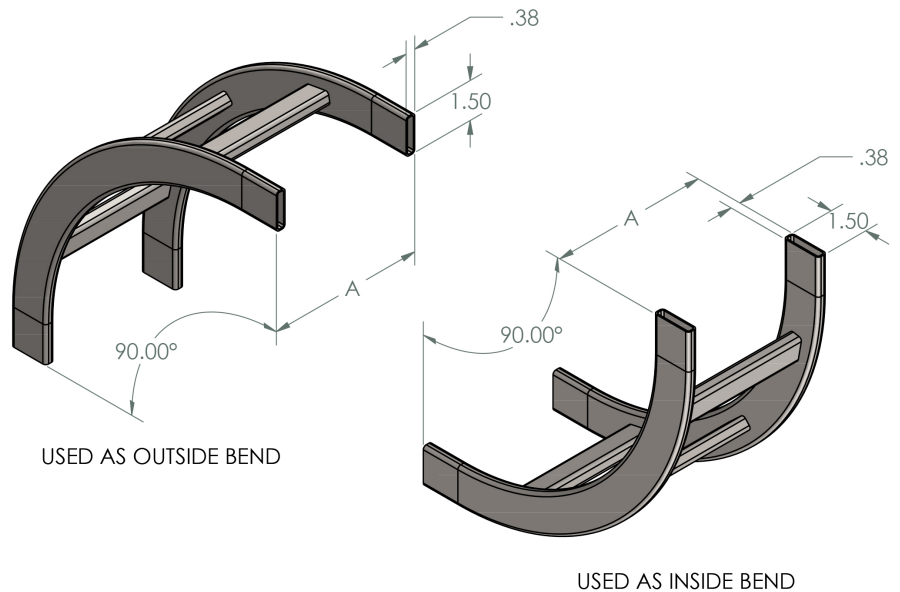

Cable ladder series summary

Model No.	Description	Weight	Function
CABLE LADDERS & ACCESSORIES — 12" Wide			
CL-1210	Straight ladder – 12"W x 10'L (approx.)	24.47 lbs	Straight section
CL-12HT	Horizontal turn ladder – 12"W	8.05 lbs	90 degree turn with minimum cable bend radius
CL-12VT	Vertical turn ladder (I/O bend) – 12"W	4.8 lbs	Changes direction of cable ladder
CLA-12RRP	Relay rack plate kit – 12"W	3.12 lbs	Secures cable ladder to top of 3" channel relay rack**
CLA-12WA	Wall angle bracket – 12"W	1.96 lbs	Provides perpendicular wall support for cable ladder
CLA-12WT	Wall triangle bracket – 12"W	4.15 lbs	Provides wall support (400 lbs. static load) for cable ladder
CLA-12RD	Cable radius drop – 12"W	1.90 lbs	Allows cable exit with proper bend radius
CABLE LADDERS & ACCESSORIES — 18" Wide			
CL-1810	Straight ladder – 18"W x 10'L (approx.)	27.75 lbs	Straight section
CL-18HT	Horizontal turn ladder – 18"W	10.50 lbs	90 degree turn with minimum cable bend radius
CL-18VT	Vertical turn ladder (I/O bend) – 18"W	5.6 lbs	Changes direction of cable ladder
CLA-18RRP	Relay rack plate kit – 18"W	4.20 lbs	Secures cable ladder to top of 3" channel relay rack**
CLA-18WA	Wall angle bracket – 18"W	2.70 lbs	Provides perpendicular wall support for cable ladder
CLA-18WT	Wall triangle bracket – 18"W	5.92 lbs	Provides wall support (400 lbs. static load) for cable ladder
CLA-18RD	Cable radius drop – 18"W	2.84 lbs	Allows cable exit with proper bend radius
ADDITIONAL HARDWARE (not size specific)			
<i>Securing Ladder to Rack</i>			
CLP-7	Rack adaptor panel, 7U	4 lbs	Mounts cable ladder to 7U opening in rack top
CLP-10	Rack adaptor panel, 10U	4 lbs	Mounts cable ladder to 10U opening in rack top
CLH-SK46	Stand-off elevation kit (4"-6")	12.00 lbs	Elevates cable ladder above rack (4" or 6")
CLH-JB3	J-bolt kit, 5/16 x 3"	0.31 lbs	Holds cable ladder to rack
<i>Securing Ladder to Wall, Floor, Ceiling</i>			
CLH-VWB	Vertical wall brackets	0.56 lbs	Anchors cable ladder to wall
CLH-CK	Ceiling-mount kit	0.88 lbs	Suspends cable ladder from ceiling
CLH-FB	Floor-mount brackets	3.22 lbs	Mounts cable ladder to floor
<i>Connecting Ladder Sections</i>			
CLH-SKB	Butt splice kit	0.47 lbs	Fastens cable ladder sections end-to-end
CLH-SKS	Swivel / adjustable splice kit	1.90 lbs	Fastens cable ladder sections providing adjustable bend
CLH-SKT	T-junction bracket kit	0.68 lbs	Fastens cable ladder sections at 90 degree intersection
CLH-SKA	Adjustable splice kit (special) *	2.0 lbs	Fastens cable ladder sections creating horizontal intersection
<i>Misc. Protection</i>			
CLH-GSK	Grounding strap kit	0.25 lbs	Provides grounding across cable ladder
CLH-EC	Ladder end caps (1pr)	0.35 lbs	Covers end of cable ladder

*Installer may cut ladder ends at special angles to fit around an obstacle

**See Lowell LRR Series racks

