



features

- **Description:** Shallow stationary base provides a subfloor 2.25" below bottom rack space. This recessed area provides a convenient space to mount accessory devices on the floor of the installation.
- **Overall Height:** 0.75" [19]
- **Overall Depth:** 20.39" [518]
- **Overall Width:** 22.45" [570]
- **Construction:** Rugged 16-gauge, fully-welded, steel construction. Black wrinkle powder epoxy finish
- **Cable Management:** Large center opening for easy cable access.
- **Hardware:** Includes hardware for bolt-on installation
- **Origin:** Made in the USA
- For use with LER, LFR and LGR Series racks. *Do not use with seismic-certified racks.*
- Does not increase rack height.
- **Optional:** 3U steel panel (SP-3) can be used to close the 13" x 5" center opening.

a&e specifications

The shallow platform base shall be Lowell Model LSSB-22, which shall be 16-gauge welded steel with black wrinkle powder epoxy. The base shall be of an inner platform design that mounts inside the rack frame to add a subfloor 2.25" below bottom rack space, with a 13" x 5" center opening for cable management. The base shall not increase overall rack height. Mounting hardware to shall be supplied.

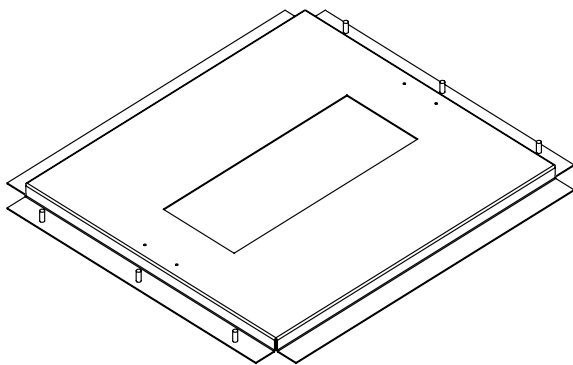

Model Summary

Model No.	Description	Overall Width	Overall Depth	Overall Height	Center Opening
LSSB-22	Shallow stationary base for 22"D rack	22.45 in / 570 mm	20.39 in / 518 mm	0.75 in / 19 mm	13 x 5 in / 330 x 127 mm
LSSB-27	Shallow stationary base for 27"D rack	22.45 in / 570 mm	25.39 in / 645 mm	0.75 in / 19 mm	13 x 5 in / 330 x 127 mm

One rack unit (RU or U) = 1.75 inches or 44.45 mm.

